

CURRENT SENSORS

WITH MAGNETIC FIELD PROBE
INDUSTRIAL APPLICATIONS

ADVANCED MATERIALS – THE KEY TO PROGRESS

VAC
VACUUMSCHMELZE

CURRENT SENSORS WITH MAGNETIC FIELD PROBE INDUSTRIAL APPLICATIONS

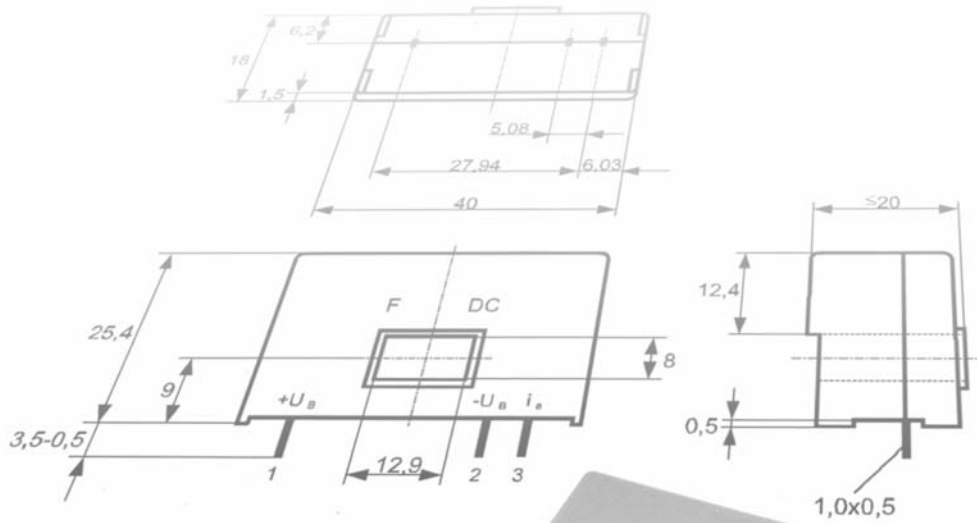

1. PREFACE

This brochure covers the standard current sensor range of VACUUMSCHMELZE GmbH & Co. KG (VAC) for the floating measurement of currents. Customized solutions are available on request.

VAC customers benefit from our comprehensive knowledge along the entire process chain. It starts with the material properties and goes over the dimensioning, the production technology and organization up to the world-wide procurement of purchased parts. VAC has decades of experience in the development, manufacturing and application of current sensors.

VAC current sensors apply in lowest up to high performance classes both in industry and in automotive applications:

- three phases drives, servo drives, generators
- power converters for DC drives
- battery operated applications
- uninterruptible power supplies
- switched mode power supplies
- welding inverters
- battery energy management

Our sensors are developed according to strictest international standards. Some types are UL approved. We also possess worldwide ISO 9001:2000 qualification.

2. TECHNOLOGIES

For current measurement, the market offers different technologies, like open- and closed loop hall effect sensors with galvanic separation, or shunts without galvanic separation.

As the only manufacturer worldwide, VAC offers current sensors, which use a soft-magnetic probe in place of the hall generator as the magnetic field detector. In relation to conventional hall effect compensation sensors, our products offer some advantages:

- very low offset current with negligible long-term drift
- practically no temperature dependence of the offset current
- very small hysteresis of the offset current
- high usable temperature range (e.g. up to 110 °C in an IGBT module)
- the magnetic module can be separated from the electronics
- no electronics adjustment necessary
- attractively priced

3. FUNCTIONAL PRINCIPLE OF VAC CURRENT SENSORS

Two major advantages of the compensation current sensors are their principle-related high linearity and their excellent dynamic properties. The current I_p to be measured is magnetically coupled to the compensation current through a soft magnetic core. The magnetic flux of this core is measured by a magnetic field detector and controlled to zero by the electronics, generating a compensation current I_s in the compensation winding. This current is proportional to the primary current I_p .

When using a Hall generator as the magnetic field detector, which is the common method, an offset voltage and the associated drift occurs. For this reason VAC has developed a sensor using a low-drift soft magnetic metallic field detector. This has made it possible to reduce the offset current and its drift considerably. A smoother run of inverter-controlled motors even at low torque operation is the result. This preserves the bearings, prolongs the service life and leads to higher accuracy, especially in machine tools.

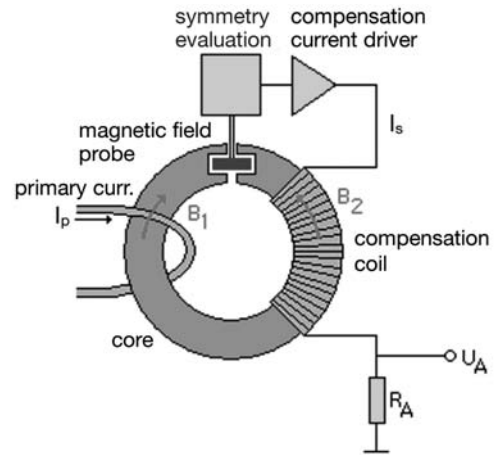

The type range of the VAC sensors offers a suitable solution for every current range and performance class.





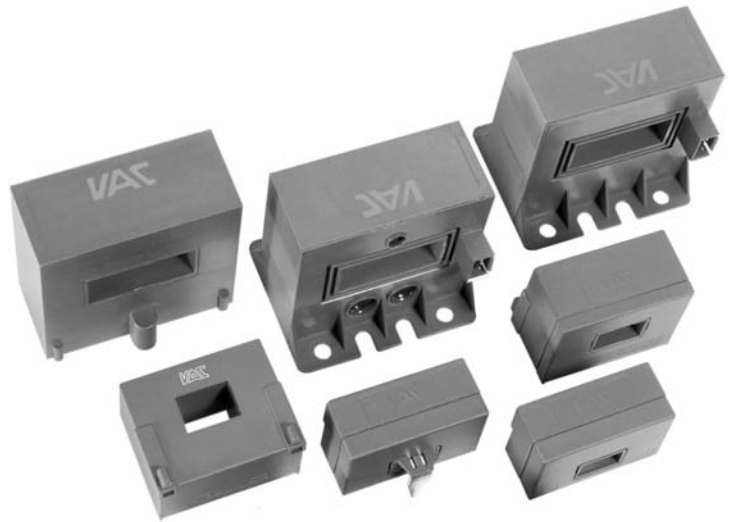



The current sensors presented here are designed for the use in appliances and systems in stationary operation. In the case of traction – or automotive – applications please contact us.

Class	Power [kW]	$I_{N, rms}$ [A]	I_{Npl} [A]
Micro	≤ 4	≤ 12	≤ 30 ≤ 42
Low-End	$> 4 \dots \leq 40$	$> 12 \dots \leq 105$	$> 30 \dots \leq 260$ $> 42 \dots \leq 370$
Midrange	$> 40 \dots \leq 200$	$> 105 \dots \leq 430$	$> 260 \dots \leq 1.075$ $> 370 \dots \leq 1.505$
High End	$> 200 \dots \leq 600$	$> 430 \dots \leq 1.080$	$> 1.075 \dots \leq 2.700$ $> 1.505 \dots \leq 3.780$
Mega	> 600	$> 1.080 \dots \leq 1.600$	$> 2.700 \dots \leq 4.000$ $> 3.780 \dots \leq 5.600$















4. TYPE RANGE

4.1 ACTIVE SCURRENT SENSORS (with integrated electronics)

Partnumber Type T60404-N ...	$I_{PN, rms}$ [A]	$I_{P, max}$ [A]	T_A [°C]	V_C [V]	K_N	f [kHz]	X @ I_{PN} , $T_A=25^\circ\text{C}$ [%]	Primary connection		Secondary connection		Integrated electronics	Potted	Incapaculated	Screw-on mounting	Drawing
								Pins	Centre hole for cable or bus bar	Pins	Connector					
	4644-X300	1-5-8-12-25	10-17-25-50	-40 ... +85	$\pm 15\text{ V}$	(1...5):1000	DC...200	0,5	•	•	•	•				7
		1-5-8-12-30	10-17-25-64	-40 ... +70												
		1-5-8-12-50	10-17-25-64	-40 ... +50												
	4644-X400	7,5-15-30	23-46-92	-40 ... +85	$\pm 15\text{ V}$	(1...4):2000	DC...100	0,5	•	•	•	•				8
		7,5-15-40	23-46-92	-40 ... +70												
		7,5-15-54	23-46-92	-40 ... +50												
	4644-X101	50	150	-40 ... +85	$\pm 15\text{ V}$	1 : 2000	DC...100	0,5	•	•	•	•				3
		100	150	-40 ... +70												
		120	150	-40 ... +55												
	4644-X100	50	70	-40 ... +85	$\pm 15\text{ V}$	1 : 1000	DC...100	0,5	•	•	•	•				3
		50	92	-40 ... +70												
	4644-X111	50	150	-40 ... +85	$\pm 15\text{ V}$	1 : 2000	DC...100	0,5	•	•	•	•				4
		100	150	-40 ... +70												
		120	150	-40 ... +55												
	4644-X112	50	70	-40 ... +85	$\pm 15\text{ V}$	1 : 1000	DC...100	0,5	•	•	•	•				4
		50	92	-40 ... +70												
	4644-X201	125	350	-40 ... +85	$\pm 15\text{ V}$	1 : 2000	DC...100	0,5	•	•	•	•				5
		200	300	-40 ... +85												
		200	350	-40 ... +70												
		250	350	-40 ... +55												
	4644-X200	125	200	-40 ... +70	$\pm 15\text{ V}$	1 : 1000	DC...100	0,5	•	•	•	•				5
		125	175	-40 ... +85												
	4644-X202	125	200	-40 ... +70	$\pm 15\text{ V}$	1 : 1000	DC...100	0,5	•	•	•	•				5
		125	175	-40 ... +85												





 = preferred type

Partnumber Type T60404-N ...	$I_{PN, rms}$ [A]	$I_{P, max}$ [A]	T_A [°C]	V_C [V]	K_N	f [kHz]	X @ I_{PN} , $T_A=25^\circ\text{C}$ [%]	Primary connection		Secondary connection		Integrated electronics	Potted	Incapsulated	Screw-on mounting	Drawing
								Pins	Centre hole for cable or bus bar	Pins	Connector					
 4644-X271	125 200 200 250	350 300 350 350	-40 ... +85 -40 ... +85 -40 ... +70 -40 ... +55	$\pm 15\text{ V}$	1 : 2000	DC...100	0,5		•	•	•					6
 4644-X052	250 400 500 200 320 400	700 700 700 560 560 560	-40 ... +105 -40 ... +85 -40 ... +70 -40 ... +105 -40 ... +85 -40 ... +70	$\pm 15\text{ V}$ $\pm 12\text{ V}$	1 : 2000	DC...50	0,5		•		•		•	•		2
 4644-X053	250 400 500 200 320 400	700 700 700 560 560 560	-40 ... +105 -40 ... +85 -40 ... +70 -40 ... +105 -40 ... +85 -40 ... +70	$\pm 15\text{ V}$ $\pm 12\text{ V}$	1 : 2000	DC...50	0,5		•		•		•	•		2
 4644-X020	200	400	-40 ... +70	$\pm 15\text{ V}$	1 : 2000	DC...50	0,5		•	•			•	•		1
 4644-X021	200	300	-40 ... +85	$\pm 15\text{ V}$	1 : 4000	DC...30	0,5		•	•			•	•		1
 4644-X031	200	300	-40 ... +85	$\pm 15\text{ V}$	1 : 4000	DC...30	0,5		•		•		•	•	•	2
 4644-X030	200	400	-40 ... +70	$\pm 15\text{ V}$	1 : 2000	DC...50	0,5		•		•		•	•	•	2
 4644-X050	400 320	425 340	-40 ... +85 -40 ... +85	$\pm 15\text{ V}$ $\pm 12\text{ V}$	1 : 5000	DC...50	0,5		•		•		•	•	•	2
 4644-X040	400 320	625 500	-40 ... +85 -40 ... +85	$\pm 15\text{ V}$ $\pm 12\text{ V}$	1 : 5000	DC...50	0,5		•		•		•	•	•	2
 4644-X060	400 320	625 500	-40 ... +85 -40 ... +85	$\pm 15\text{ V}$ $\pm 12\text{ V}$	1 : 5000	DC...50	0,5		•		•		•	•	•	2
 4644-X055	250 400 500 200 320 400	700 700 700 560 560 560	-40 ... +105 -40 ... +85 -40 ... +70 -40 ... +105 -40 ... +85 -40 ... +70	+15 V $\pm 12\text{ V}$	1 : 2000	DC...50	0,5		•		•		•	•		2
 4644-X056	500	1000	-40 ... +75	$\pm 24\text{ V}$	1 : 3000	DC...50	0,5		•		•		•	•		2
 4644-X054	250 400 700 200 320 400	1250 1250 1250 1000 1000 1000	-40 ... +105 -40 ... +85 -40 ... +70 -40 ... +105 -40 ... +85 -40 ... +70	$\pm 15\text{ V}$ $\pm 12\text{ V}$	1 : 3000	DC...50	0,5		•		•		•	•		2

4.2 PASSIVE CURRENT SENSORS

(with separated electronics)







Partnumber Type T60404-M ...	$I_{PN, rms}$	I_{Pmax}	T_A	V_C	K_N	f	X @ I_{PN} $T_A=25^\circ C$	Primary connection		Secondary connection		Electronics			Potted	Incapsulated	Screw-on mounting	Crawling		
								Pins	Centre hole for cable or bus bar	Pins	Connector	Integrated	Separated	Number						
														One phase					Two phases	Three phases
	4645-X010	3-6-10-20 6-12-20-40	27 60	-40 ... +85	+5 V ± 15 V	(1...6):1000	DC...100	0,5	•	•		•	1,4	2	3	•	•	9		
	4645-X011	6-12-20-40	55	-40 ... +85	± 15 V	(1...6):3000	DC...100	0,5	•	•		•	1	2	3	•	•	9		
	4645-X012	6-12-20-40	60	-40 ... +85	± 15 V	(1...6):1000	DC...100	0,5	•	•		•	1	2	3	•	•	9		
	4645-X211	10-16-25-50	90	-40 ... +85	+5 V	(1...5):1000	DC...100	0,5	•	•		•	4			•	•	11		
	4645-X050	100	160	-40 ... +85	± 15 V	1 : 1000	DC...100	0,5		•	•		•	1	2	3	•	•	10	
	4645-X051	100	142	-40 ... +85	± 15 V	1 : 2000	DC...100	0,5		•	•		•	1	2	3	•	•	10	
	4645-X070	200	400	-40 ... +85	± 15 V	1 : 2000	DC...50	0,5		•	•		•	1	2	3	•	•	1	
	4645-X072	200	400	-40 ... +85	± 15 V	1 : 3000	DC...30	0,5		•	•		•	1	2	3	•	•	1	

 = preferred type

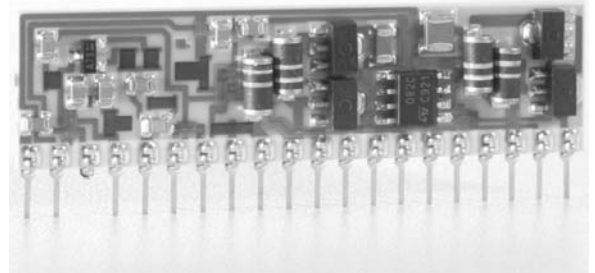
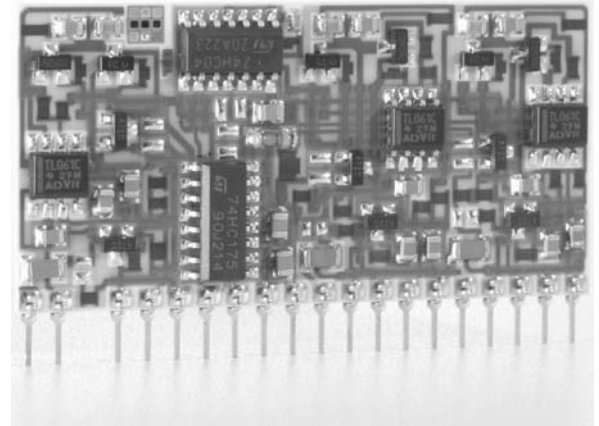
4.3 ELECTRONICS

(for passive current sensors)

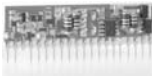

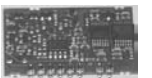
Partnumber Type T60404-Q ...	connectable magnetic modules	I_c [mA]	V_c [V]	P_{VE0} [mW]	$P_{VE, max}$ [W]	Number
 5790-X013	1	14	$\pm 15\text{ V} \pm 5\%$	420	1	1
 5790-X023	2	19	$\pm 15\text{ V} \pm 5\%$	570	1	2
 5790-X101	3	50	$\pm 15\text{ V} \pm 5\%$	750	2	3
 5790-X052	1	35	$+5\text{ V} \pm 5\%$	175		4

4.4 DIMENSIONAL DIAGRAMS OF SENSORS

Drawing No. 1

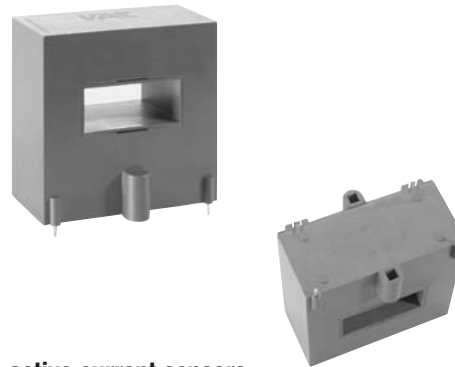
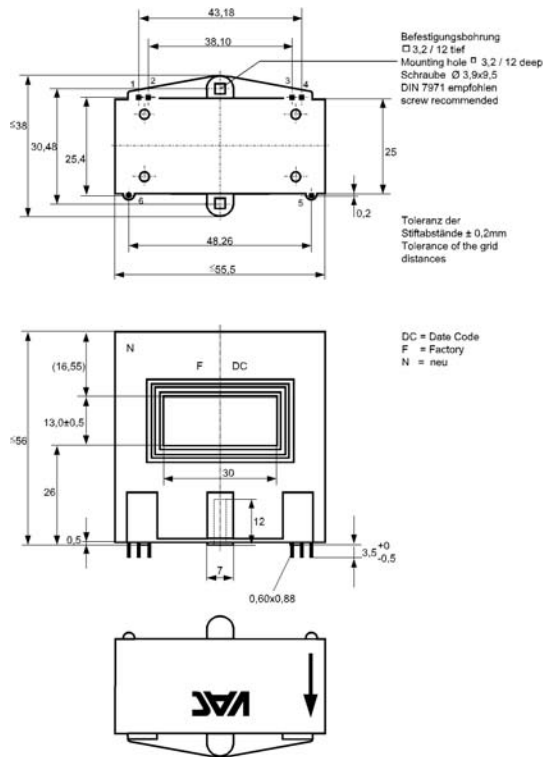

active current sensors:

- T60404-N4644-X020
- T60404-N4644-X021

passive current sensors:

- T60404-M4645-X070
- T60404-M4645-X072

Drawing No. 2

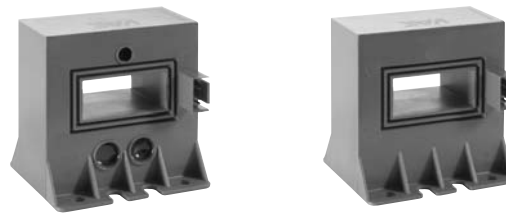
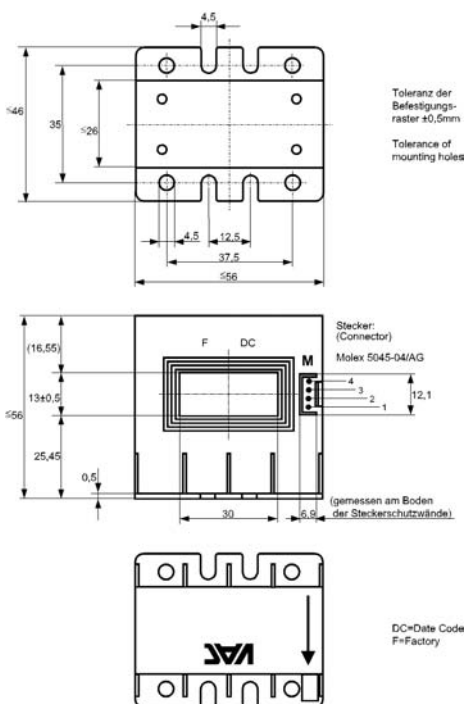

potted version

incapsulated version

active current sensors:

- T60404-N4644-X053
- T60404-N4644-X054
- T60404-N4644-X055
- T60404-N4644-X056

active current sensors:

- T60404-N4644-X052
- T60404-N4644-X030
- T60404-N4644-X031
- T60404-N4644-X040
- T60404-N4644-X050
- T60404-N4644-X051
- T60404-N4644-X060

passive current sensors:

not available in this casing

4.4 DIMENSIONAL DIAGRAMS OF SENSORS

Drawing No. 3

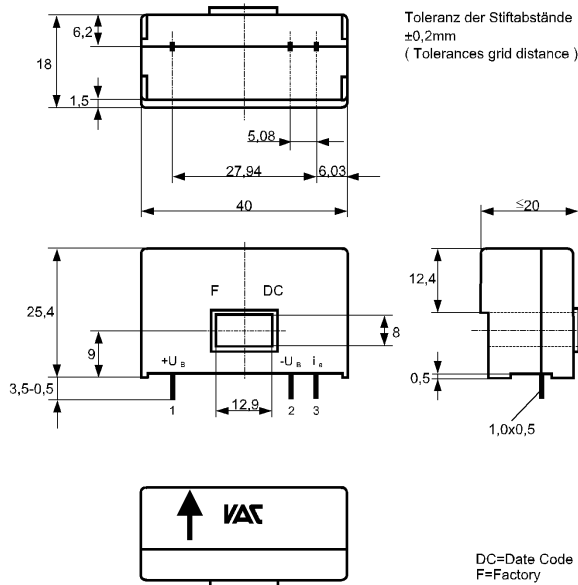

active current sensors:
T60404-N4644-X101
T60404-N4644-X100

passive current sensors:
not available in this casing

Drawing No. 4

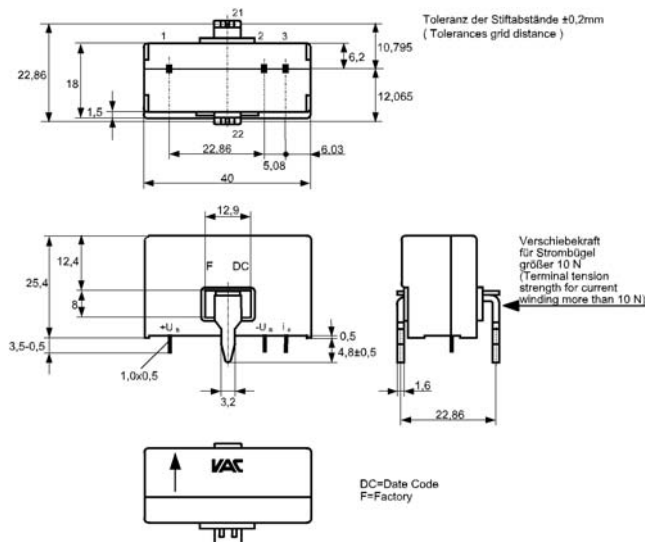

active current sensors:
T60404-N4644-X111
T60404-N4644-X112

passive current sensors:
not available in this casing

Drawing No. 5

Anschluß Nr.1,2,3 = 1,0x0,5
 Anschluß Nr.4,5 = 0,88x0,6
 (Connector)
 Toleranz der Stiftabstände ±0,2mm
 (Tolerances grid distance)
 Befestigungsbohrung
 □ 3,2 / 13 tief
 Mounting hole □ 3,2 / 13 deep
 Schraube Ø 3,9x9,5
 DIN 7971 empfohlen
 screw Ø3,9x9,5 recommended

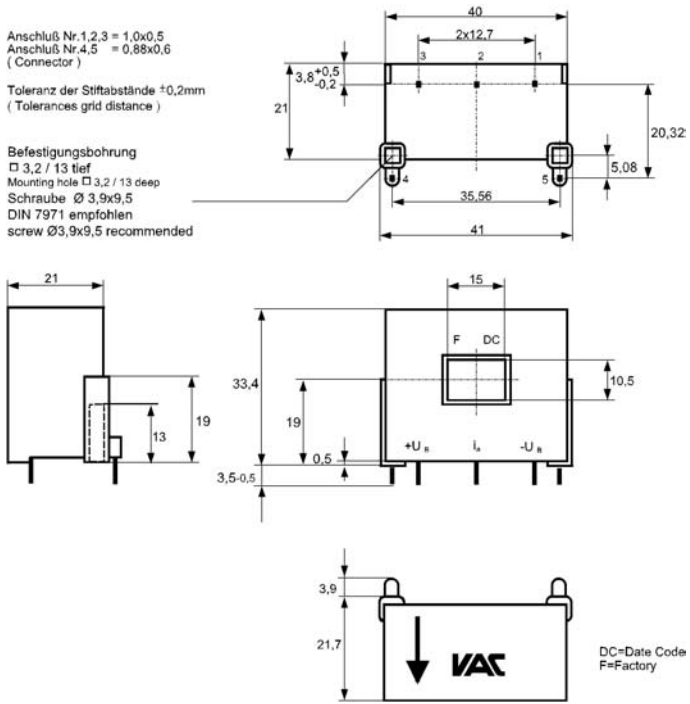

active current sensors:

T60404-N4644-X200
 T60404-N4644-X201
 T60404-N4644-X202

passive current sensors:

not available in this casing

Drawing No. 6

DC=Date Code
 F=Factory

*=vorläufig
 (preliminary)

Toleranz der Stiftabstände ±0,3mm
 (Tolerances grid distance)

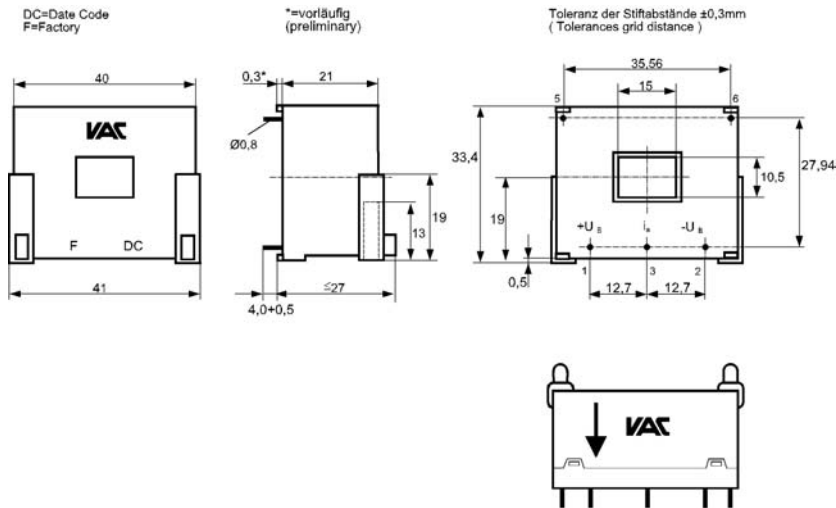

active current sensors:

T60404-N4644-X271

passive current sensors:

not available in this casing

4.4 DIMENSIONAL DIAGRAMS OF SENSORS

Drawing No. 7

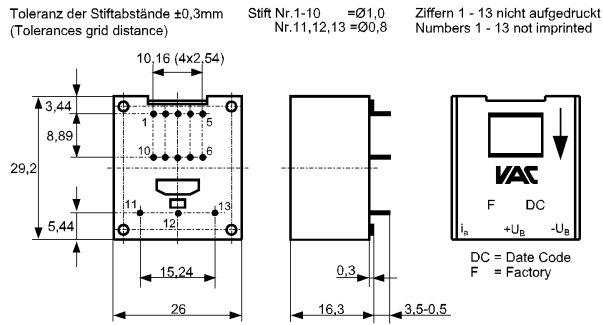

active current sensors:
T60404-N4644-X300

passive current sensors:
not available in this casing

Drawing No. 8

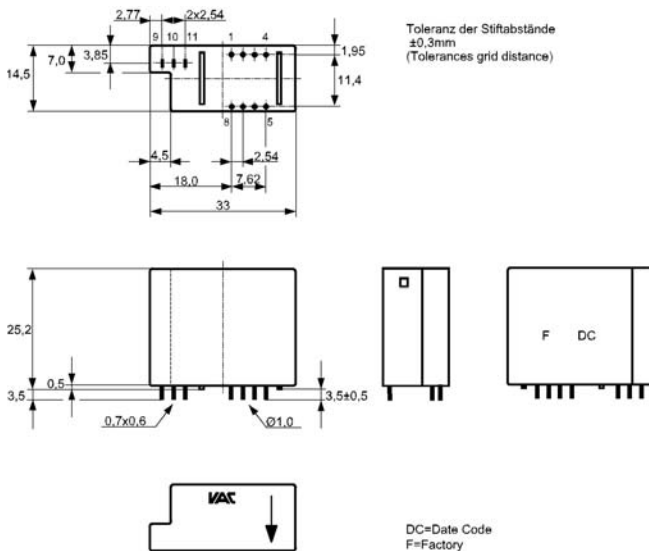

active current sensors:
T60404-N4644-X400

passive current sensors:
not available in this casing

Drawing No. 9

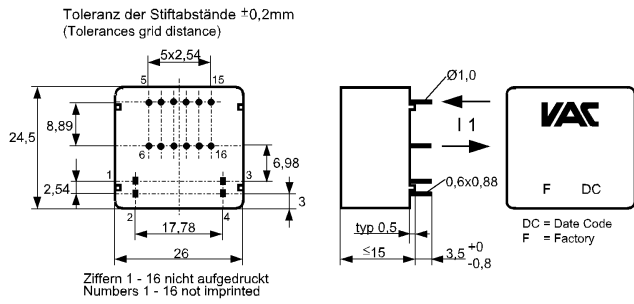

active current sensors:
not available in this casing

passive current sensors:
T60404-N4645-X010
T60404-N4645-X011
T60404-N4645-X012

Drawing No. 10

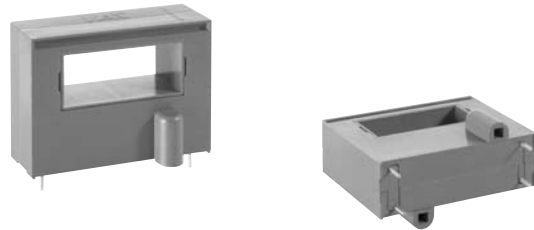
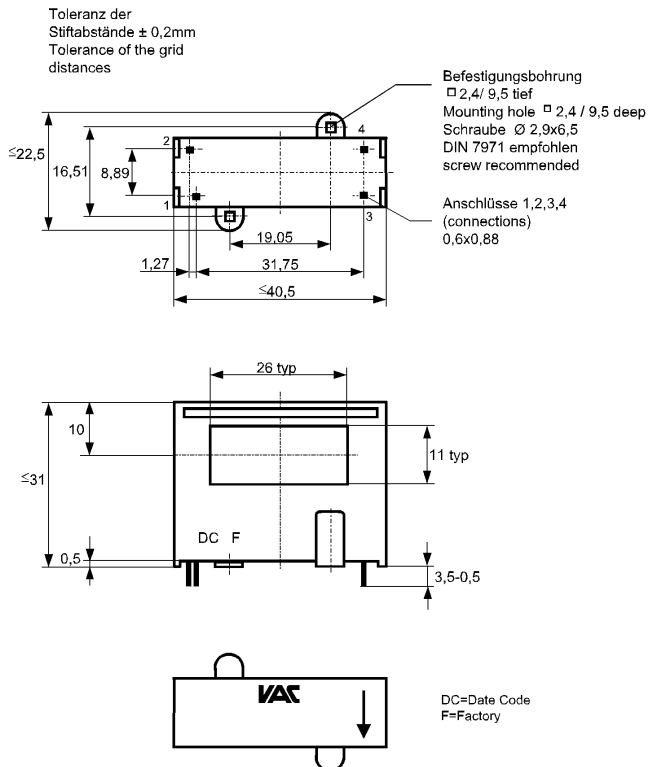

active current sensors:
not available in this casing

passive current sensors:
T60404-N4645-X050
T60404-N4645-X051

4.4 DIMENSIONAL DIAGRAMS OF SENSORS

Drawing No. 11

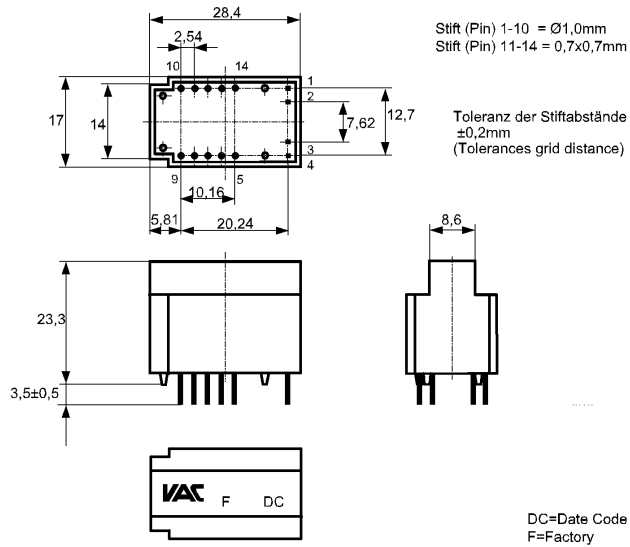

active current sensors:
not available in this casing

passive current sensors:
T60404-N4645-X211

5. ABBREVIATIONS AND TERMINOLOGY

Unit	Description	
C_k	pF	Maximum possible coupling capacity (primary - secondary)
$\Delta I_0/\Delta V_C$	mA/V	Supply voltage rejection ratio
$\Delta t (I_{p,max})$	μs	Delay time at $di/dt = 100 \text{ A/ms}$
$\Delta V_0/\Delta T_A$	$\mu V/^\circ C$	Offset voltage drift @ $T_A = -40 \dots +85^\circ C$
$\Delta V_{out}/\Delta T_A$	V/ μs	Slew rate output voltage
$\Delta \Phi (S1-S2)$	nVs	Magnetic flux sensor
ϵ_L	%	Linearity
f	kHz	Frequency range
I_0	mA	Offset current @ $I_p=0, T_A=25^\circ C$
I_{0ges}	A	Offset current (including I_0, I_{0t}, I_{0T})
I_{0H}	mA	Hysteresis current @ $I_p=0$ caused by primary current $3 \times I_{PN}$
I_{0t}	mA	Offset current drift
I_{0T}	mA	Offset current temperature drift @ $T_A = -40 \dots +85^\circ C$
I_C	mA	Supply current
I_{comp}	mA	Compensation current
i_{oss}	mA	Offset ripple
$I_{p,max}$	A	maximum measuring range @ $R_M = 100 \Omega$
I_{PN}	A	Primary rated current, RMS
$I_{S,max}$	mA	Maximum output current
I_{SN}	A	Output rated current, RMS
K_N		Transformation ratio
m	g	Mass
P_{VE0}	mW	No load power losses
$P_{VE,max}$	W	Maximum permissible power loss @ $T_A = 70^\circ C$
$R(S1-S2)$	Ω	Winding resistance magnetic probe coil
R_M	Ω	Load resistance
R_P	Ω	Primary coil resistance per turn @ $T_A = 25^\circ C$
R_S	Ω	Secondary coil resistance @ $T_A = 85^\circ C$
$R_S(K1-K2)$	Ω	Winding resistance compensation winding

Unit	Description	
T_A	$^\circ C$	Ambiente temperature
t_r	μs	Response time
T_S	$^\circ C$	Storage temperature range
V_0	V	Offset voltage vs. reference voltage
V_b	V	Working voltage
V_c	V	Supply voltage
V_{Ctot}	V	Maximum supply voltage (without function)
V_d	kV	Test voltage, RMS, 1s
V_e	kV	Partial discharge voltage
V_{K1}	V	Voltage at K1
V_{out}	V	Output voltage
V_{Ref}	V	Reference voltage
X	%	Measuring accuracy @ $I_{PN}, T_A = 25^\circ C$
X_{Ti}	%	Temperatur drift of X @ $T_A = -40 \dots +85^\circ C$



VACUUMSCHMELZE GMBH & CO. KG

GRÜNER WEG 37
D-63450 HANAU / GERMANY
PHONE +49 6181 38 0
FAX +49 6181 38 2645
INFO@VACUUMSCHMELZE.COM
WWW.VACUUMSCHMELZE.COM

VAC SALES USA LLC

2935 DOLPHIN DRIVE
SUITE 102
42701 ELIZABETHTOWN KY / USA
PHONE +1270 769-1333
FAX +1270 765 3118
INFO-USA@VACUUMSCHMELZE.COM

**VACUUMSCHMELZE
SALES OFFICE SINGAPORE**

300 BEACH ROAD
#31-03 THE CONCOURSE
SINGAPORE 199555
PHONE +65 6391 2600
FAX +65 6391 2601
VAC.SINGAPORE@VACUUMSCHMELZE.COM

KB - CURRENT SENSORS - EDITION 2007

Published by VACUUMSCHMELZE GmbH & Co. KG, Hanau
© VACUUMSCHMELZE 2007. All rights reserved.

As far as patents or other rights of third parties are concerned, liability is only assumed for products per se, not for applications, processes and circuits implemented within these products. The information describes the type of product and shall not be considered as assured characteristics. Terms of delivery and rights to change design reserved.